

Pos.	Beschreibung Description	Maße Measurement	Anzahl Quantity	Art.-Nr. Item
1	Vorderteil Front part	650 x 780 x 35 mm	1	39531-30
2	Rückwand Back wall	650 x 780 x 35 mm	1	39531-31
3	Seitenteil, links/rechts Left/right side panel	660 x 380 x 30 mm	2	39531-20
4	Vordere Bodenplatte Front base plate	615 x 330 x 20 mm	1	39531-10
5	Hintere Bodenplatte Back base plate	615 x 330 x 20 mm	1	39531-11
6	Dachhälfte, rechts Right roof part	855 x 520 x 30 mm	1	39531-40
7	Dachhälfte, links Left roof part	855 x 520 x 30 mm	1	39531-41
8	Dachfirst Roof ridge	880 x 70 x 60 mm	1	39531-50

Pos.	Beschreibung Description	Größe Size	Anzahl Quantity	Art.-Nr. Item
A	Gewindeschraube mit Mutter Thread screw with nut	M6 x 60 mm	8+1	3953-60
B	Senkkopfschraube Countersunk screw	ø 3,5 x 35 mm	12+1	

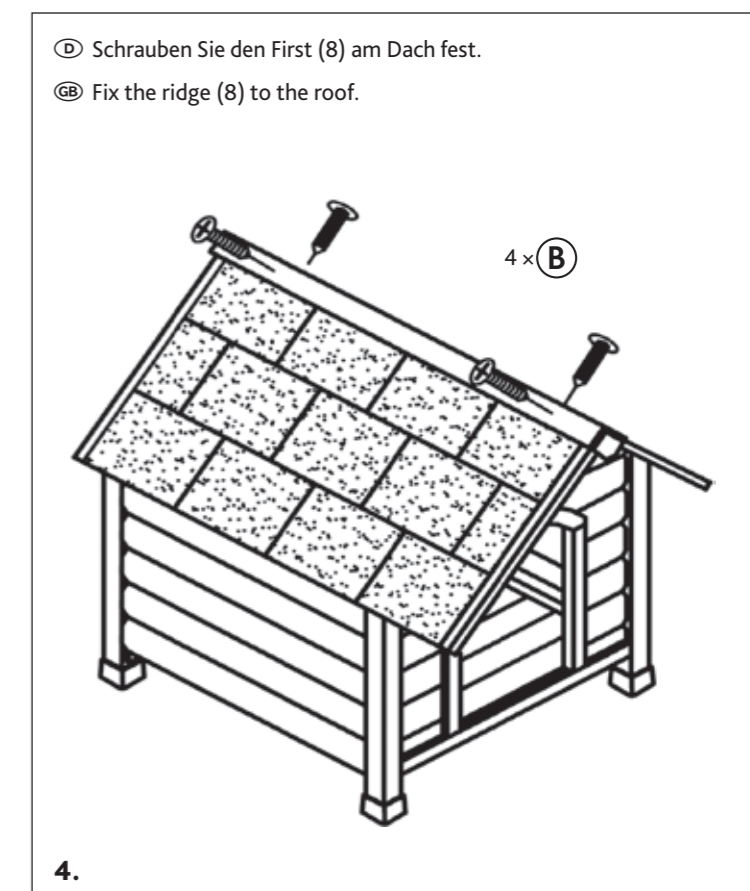
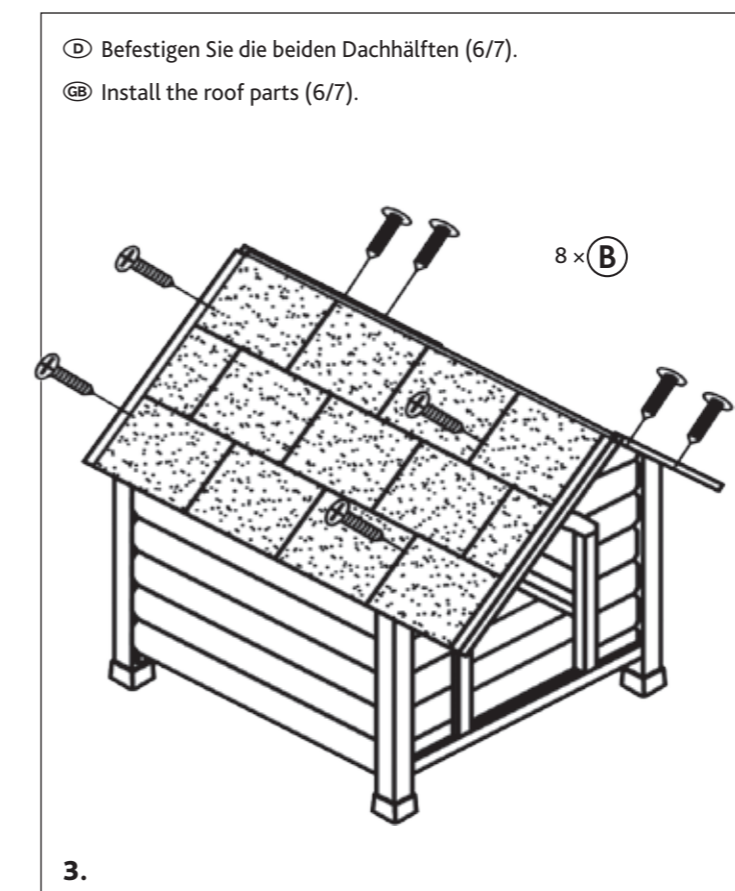
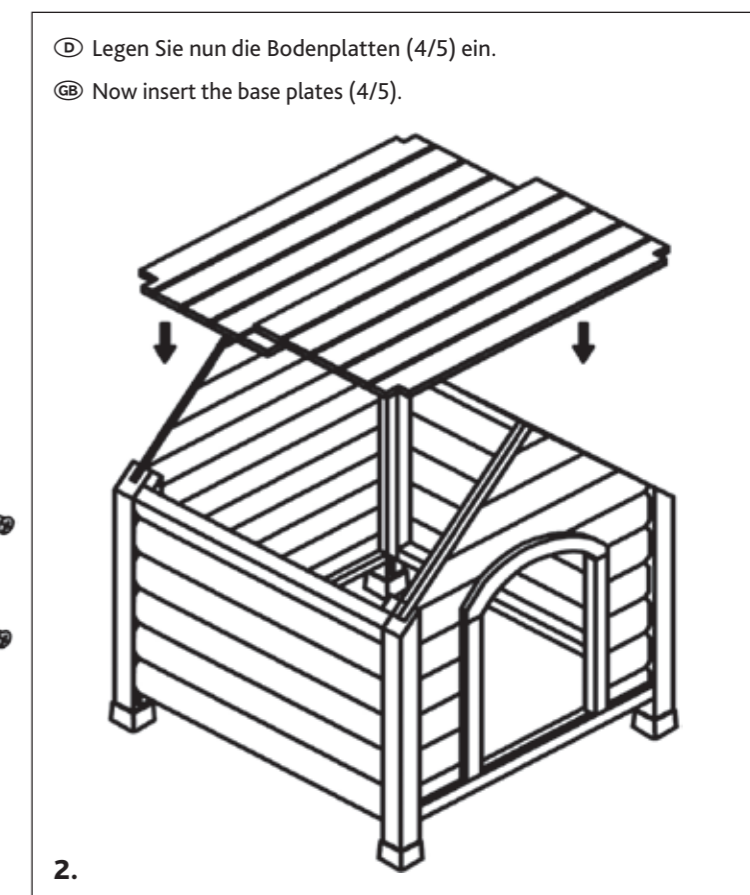
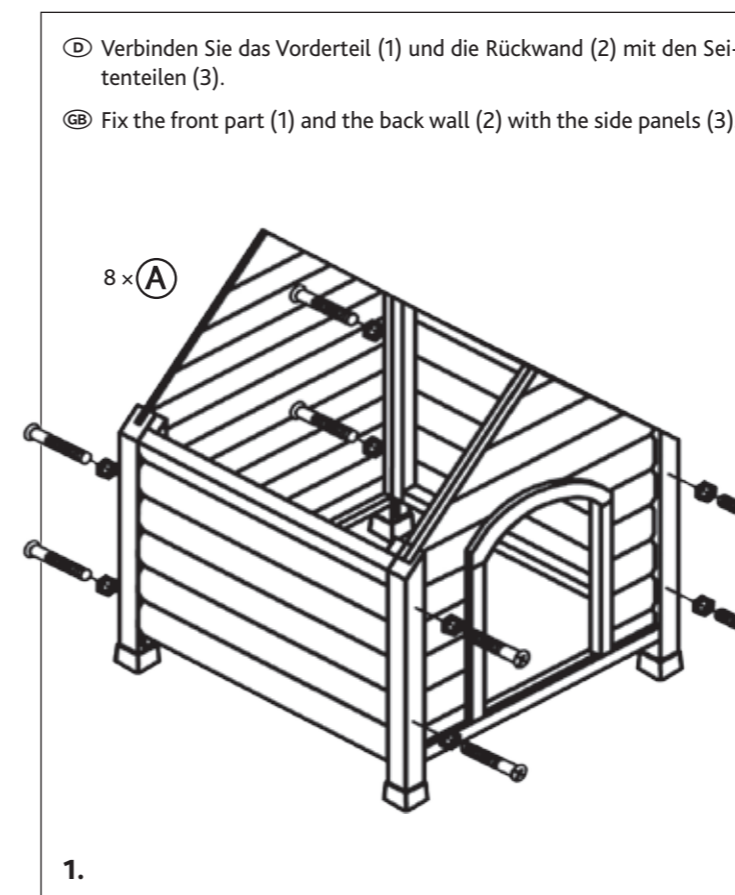

Ⓧ Sie finden eine französische und italienische Anleitung unter der jeweiligen Artikel-Nummer auf www.trixie.de.
 Ⓧ Please find instructions in French and Italian under the corresponding item number at www.trixie.de.
 Ⓧ Vous trouverez les informations détaillées en français et en italien à chaque référence d'article, sur notre site www.trixie.fr.
 Ⓧ Le istruzioni in italiano e francese sono disponibili selezionando il codice dell'articolo sul nostro sito www.trixie.it.